

Specification

Indirect Lighting

Direct Lighting

Wall Wash



Brand

VIEW OF US
Worldwide Innovation Brand of Indoor LED Lighting

BRAND POSITIONING
LED Linear Lighting Solution Provider

BRAND STYLE
Concise | Trendy | Innovative

BRAND VALUE
Concentration | Profession | Acme | Innovation | Creation

CONSIDERATION OF DESIGN
Simplification | User-friendly | Consumption

Production Facility

THE OLORS

Wall Washing



SKYLINE

Design principles

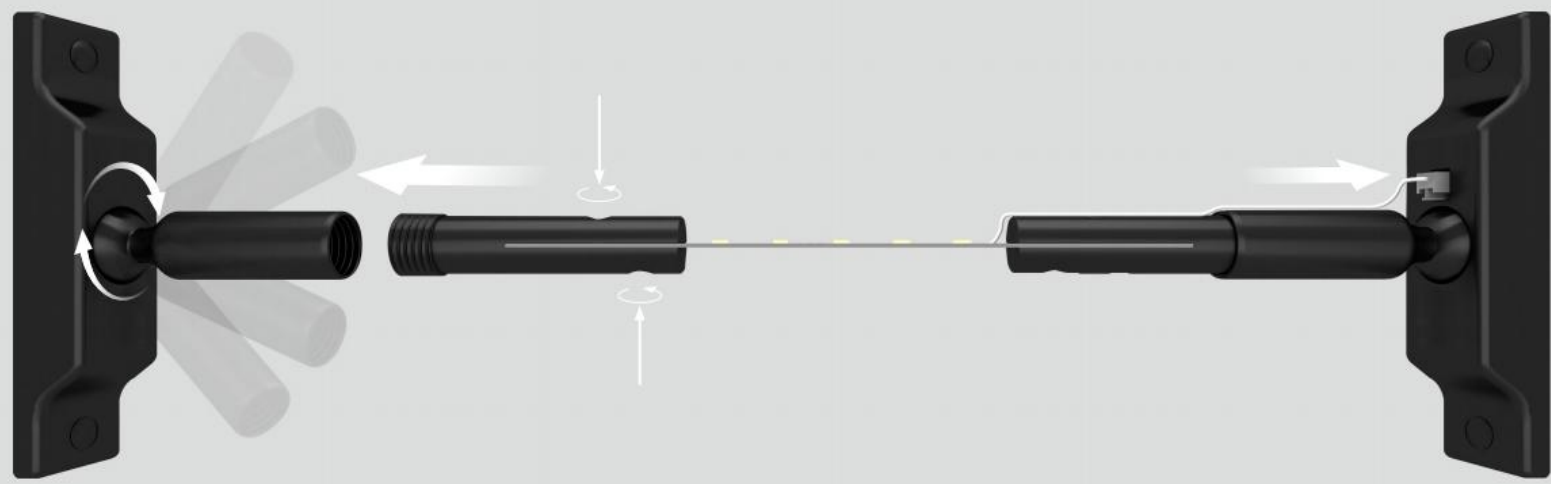

Application Guidelines

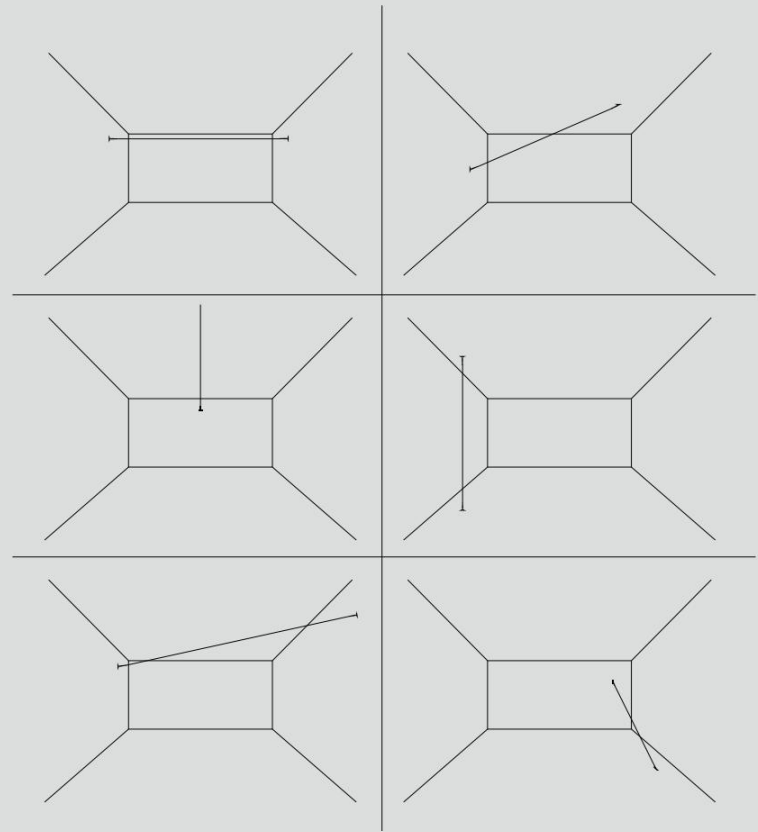
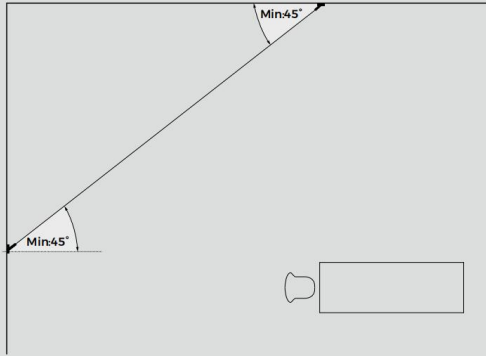
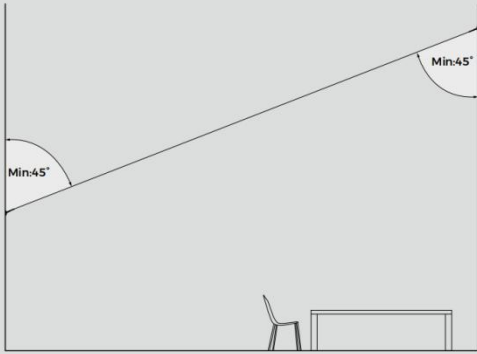

Installation guidelines

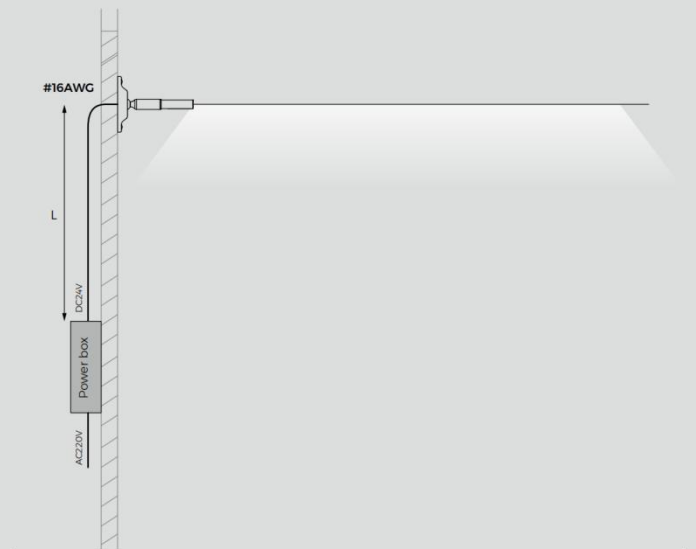
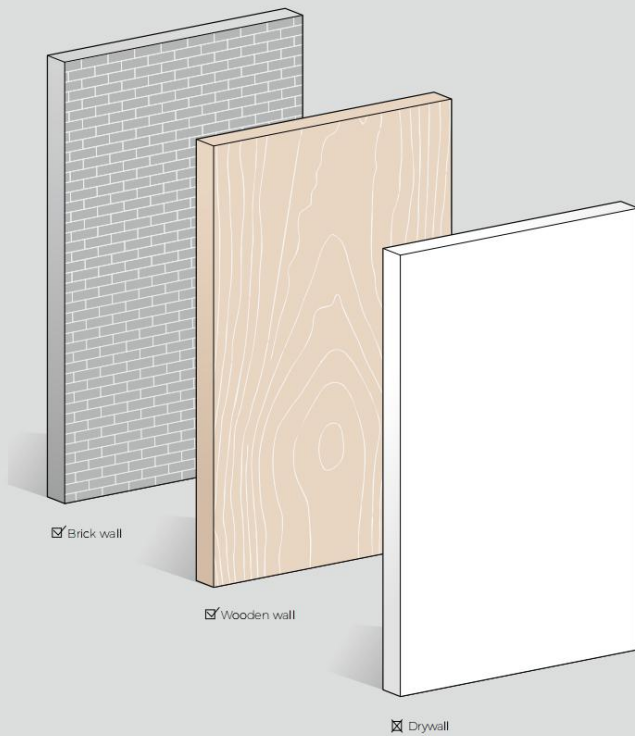





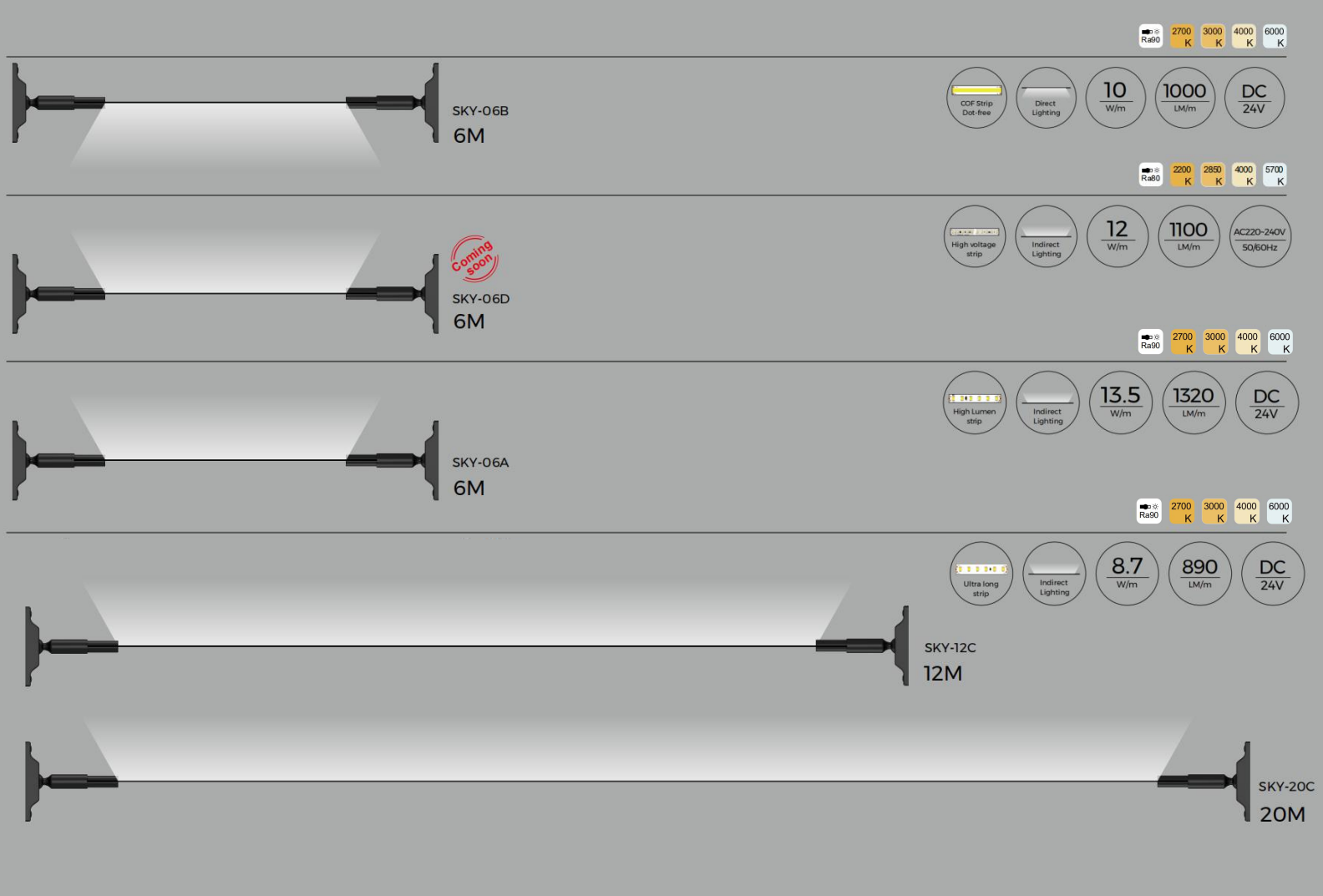









SKY-06A: Lmax=9M; 13.5W/m; DC24V
 SKY-06B: Lmax=9M; 10W/m; DC24V
 SKY-12C: Lmax=7M; 8.7W/m; DC24V
 SKY-20C: Lmax=5M; 8.7W/m; DC24V
 SKY-06D: AC220-240V; Driverless

*Please calculate the required power according to the actual length



Parameters

Model	SKY-06B	SKY-06D Coming soon	SKY-06A	SKY-12C	SKY-20C
Length	6M	6M	6M	12M	20M
Lighting source					
Cutting Unit	62.5mm	250mm	50mm	50mm	50mm
Input voltage	DC24V	AC220~240V 50/60Hz	DC24V	DC24V	DC24V
CCT					
CRI	>90	>80	>90	>90	>90
Typ. power	10W/m	12W/m	13.5W/m	8.7W/m	8.7W/m
Lumens	1000LM/m	1100LM/m	1320LM/m	890LM/m	890LM/m
Color					

Optical & electronic data

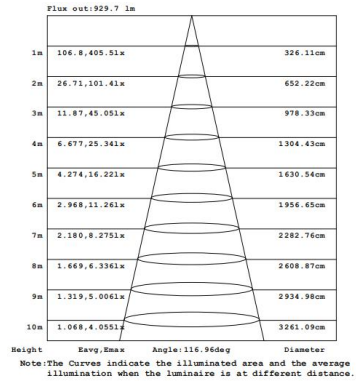
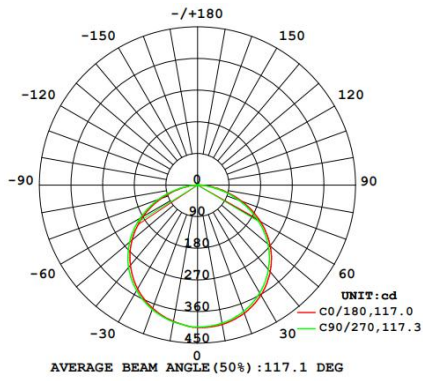

A

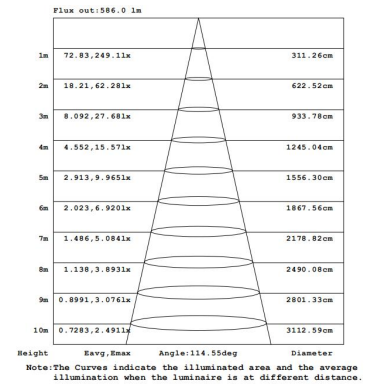
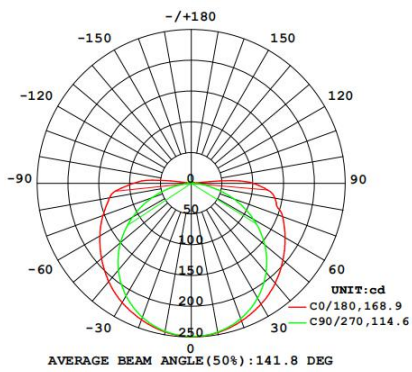

B

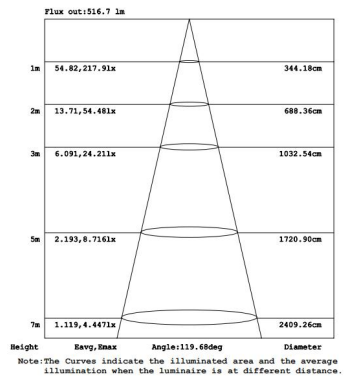
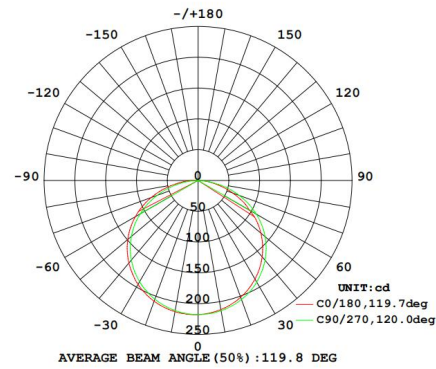

C

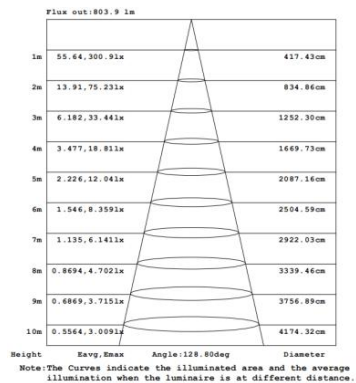
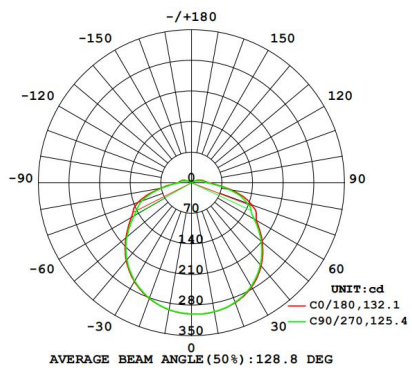

D

Packing



Components	Packaging material	Size(mm)	Type	GW	Content
Single piece	Hat box	352*346*70mm	6m	2kg	1pcs
Whole bundle	Hat box	365*360*295mm	6m	8kg	4pcs
Single piece	Hat box	352*346*70mm	12m	2.52kg	1pcs
Whole bundle	Hat box	365*360*295mm	12m	10.08kg	4pcs
Single piece	Hat box	352*346*70mm	20m	3.15kg	1pcs
Whole bundle	Hat box	365*360*295mm	20m	12.6kg	4pcs

Ordering code

Category			Length		Light Source Type		CRI		CCT		Color		
Skyline	SKY	-	6000mm	06	D8120-24V-8mm	A	>90	9	2200K	22	White	W	
			12000mm	12	DF10-24V-8mm	B	>80	8	2700K	27	Black	B	
			20000mm	20	DS8120-24V-8mm	C			2850K	28			
					H8104-230V-12mm	D			3000K	30			
								4000K	40				
										5700K	57		
										6000K	60		
	SKY	-		06		A		8		40		W	

SKY-06A840W



Attentions :

- Please install the product in the right environment as much as possible ;
- Please be careful during operation. Do not touch the AC power supply in case of electric shock ;
- Check the current through the circuit, such as the surge occurs when press the switch does not exceed the maximum rated current, please insert the appropriate protection circuit ;
- This product is sensitive to static electricity, and please special attention. In particular, it will damage the product when the static electricity is more than absolute maximum rated current and voltage, please make a countermeasures to avoid the damage of the static electricity and surge when using the product.



Huacai (Shenzhen) Opto-Electronics Co.,Ltd

Building A5, Qixing Wisdom Park,Shiyan
Youth Road, Bao'an District, Shenzhen, China

E-mail: colors@colorsled.com

Tel: +86-755-2923 1888

www.colorsled.com