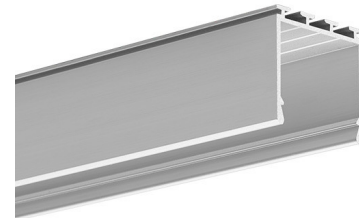

PRODUCT DESCRIPTION

- Ability to create a line of light
- Easy mounting using various techniques
- Can be combined in straight and broken linear runs

FINISH :

Silver anodized Black anodized RAL 

Fill empty fields

Product nr.	
Fixture type	
Company	
Job name	
Date	

TECHNICAL SPECIFICATION

Application

- surface mounted or suspended lighting fixtures

Assembly

- using surface springs
- using suspension accessories
- using mounting adhesive

Additional information

- ability to construct polygonal fixtures using ZM connectors

AVAILABLE LENGTHS

Ref. nr.	surface finish	available lengths
B5554ANODA_1	Silver anodized	1000 mm
B5554ANODA_2	Silver anodized	2000 mm
B5554ANODA_3	Silver anodized	3000 mm

TECHNICAL DRAWING

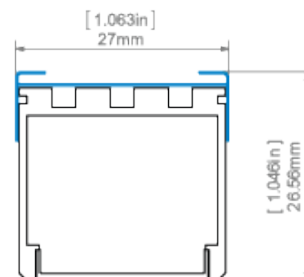
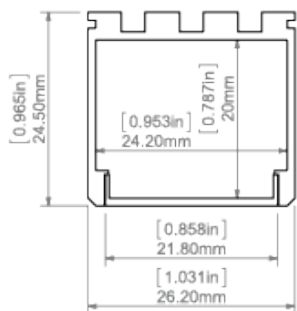

LIPOD profile and AM-24 mounting bracket
profil LIPOD z mocownikiem AM-24

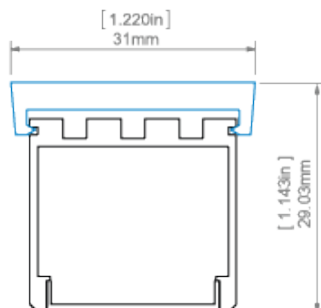

LIPOD profile and GIP mounting bracket
profil LIPOD i mocownikiem GIP

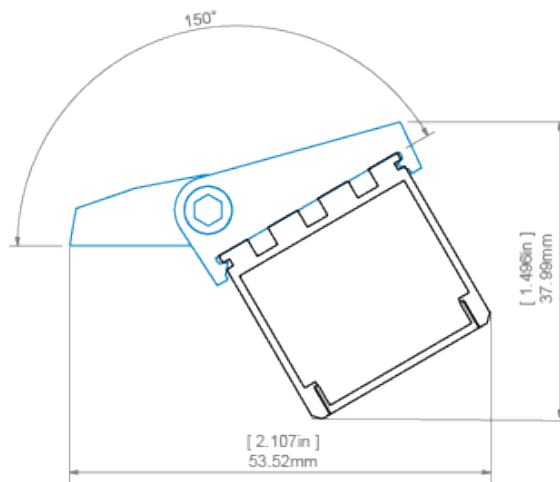

LIPOD profile and REGIP-UV mounting bracket
profil LIPOD z mocownikiem REGIP-UV

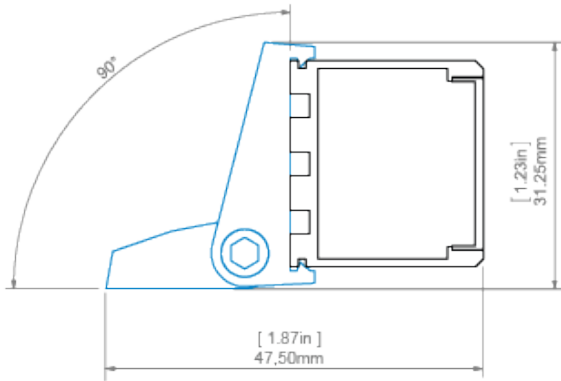

LIPOD profile and REGIP-UV mounting bracket
profil LIPOD z mocownikiem REGIP-UV

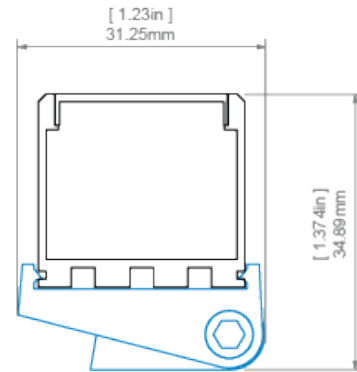

LIPOD profile and REGIP-UV mounting bracket
profil LIPOD z mocownikiem REGIP-UV

RELATED PROFILES

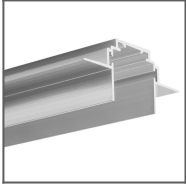

TEKNIK-ZM Profile
Ref: C0399

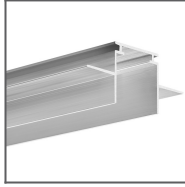

TEKNIK Profile
Ref: B5555V1

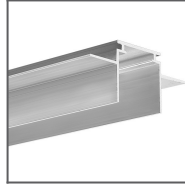

TEKUS Profile
Ref: B6638V1

RELATED PRODUCTS

COVERS

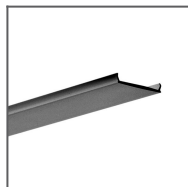

LIGER-22 black Cover
Ref: 17044

80°

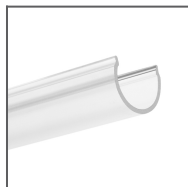

G-L clear Cover
Ref: 17006

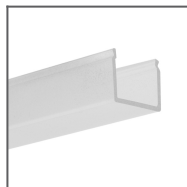

G-K semi-transparent
Cover
Ref: 00415

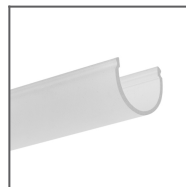

G-L semi-transparent
Cover
Ref: 17008

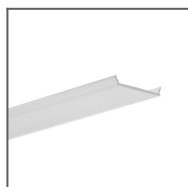

MUN-22 semi-transparent
Cover
Ref: 17042

60°

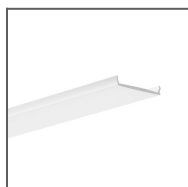

LIGER-22 frosted
Cover
Ref: 17032V1

110°

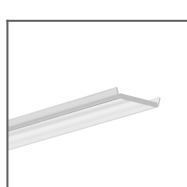

HS-22 clear Cover
Ref: 17022

70°

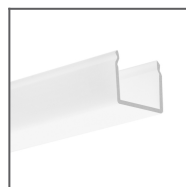

G-K frosted Cover
Ref: 17007

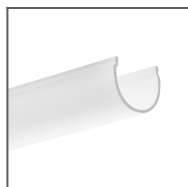

G-L frosted Cover
Ref: 00413

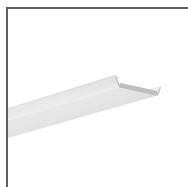

HS-22 frosted Cover
Ref: 17011

100°



END CAPS

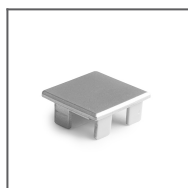

LIPOD metalized
End cap
Ref: 24051



LIPOD grey End
cap
Ref: 24004

ACCESSORIES



BZP Head
Ref: 42213



BZP-ZO Head
Ref: 42214



BZP-ZZ Head
Ref: 42215

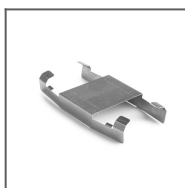

AM-24 Mounting
bracket
Ref: 24235



GIP Mounting
bracket
Ref: 24143



REGIP-UV
Mounting bracket
Ref: 24271



DP Fastener
Ref: 00644



DP-ZO Fastener
Ref: 00649



DP-ZZ Fastener
Ref: 00651



TEKNIK Latch
Ref: 24003

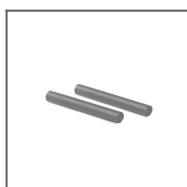

ZM Block
Ref: 42520

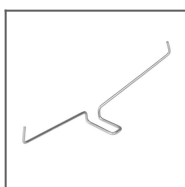

GP Spring
Ref: 00293



M11 Fastener set
Ref: 42609



M12 Fastener set
Ref: 42610

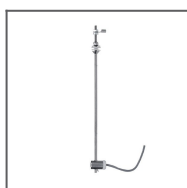

M13 Fastener set
Ref: 42611



W1 Fastener set
Ref: 42602

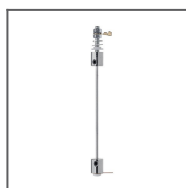

W6 Fastener set
Ref: 42604



W7 Fastener set
Ref: 42605



8,8x1,2 Gland
Ref: 00802

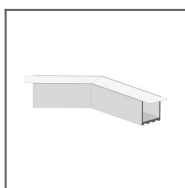

L135 LIPOD
Coupler
Ref: _

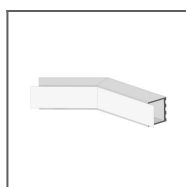

L135PW LIPOD
Coupler
Ref: _

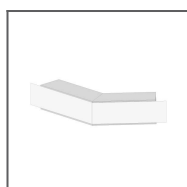

L135PZ LIPOD
Coupler
Ref: _

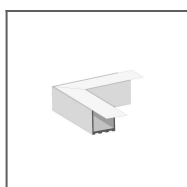

L90 LIPOD
Coupler
Ref: _

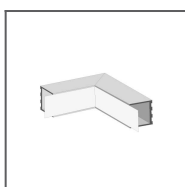

L90PW LIPOD
Coupler
Ref: _



L90PZ LIPOD
Coupler
Ref: _

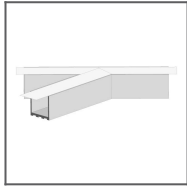

T135L LIPOD
Coupler
Ref: _

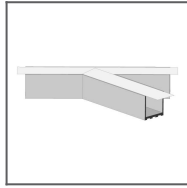

T135R LIPOD
Coupler
Ref: _

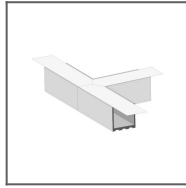

T90 LIPOD
Coupler
Ref: _

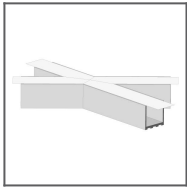

X135 LIPOD
Coupler
Ref: _

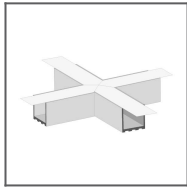

X90 LIPOD
Coupler
Ref: _

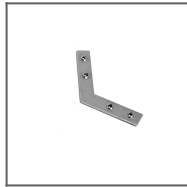

ZM-120
Connector
Ref: 42728

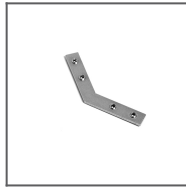

ZM-135
Connector
Ref: 42720



ZM-180
Connector
Ref: 42717



ZM-90 Connector
Ref: 42716

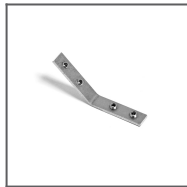

ZM-PION-135
Connector
Ref: 42719



ZM-PION-90
Connector
Ref: 42718



Fi-3 Isolating
bases
Ref: 42203



Fi-5 Isolating
bases
Ref: 42204



Fi-6 Isolating
bases
Ref: 42205

MARKETING MATERIALS



Display
P230-90072M
Ref: 90072M